

Stacking Style (Choose One):

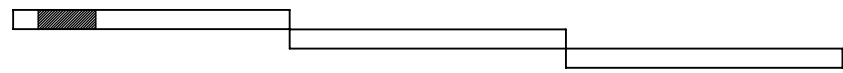

Southern Stack Close Left

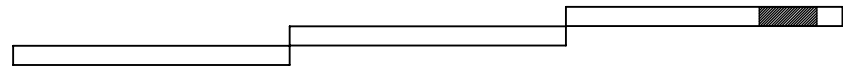

Southern Stack Close Right

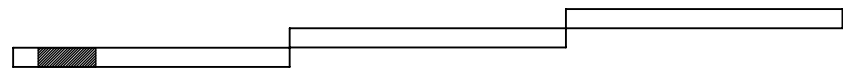

Northern Stack Close Left

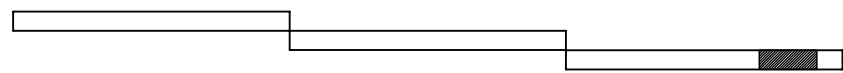

Northern Stack Close Right

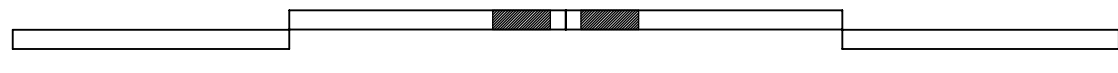

Bi-parting Southern Stack

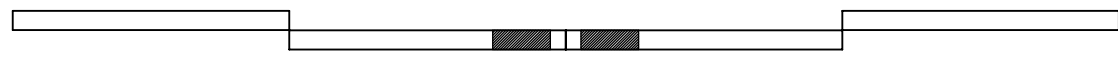

Bi-parting Northern Stack

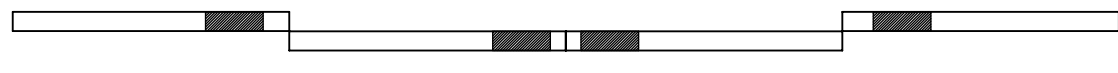

Independently Powered

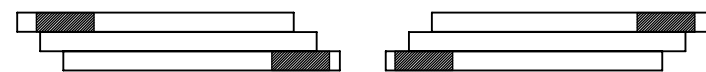

Floating

Operator Mounting Style:

Outside (OD)

Inside (ID)

For Bottom Members With A Width Of 8" Or less, An OD Mounted Operator May Be Recommended.

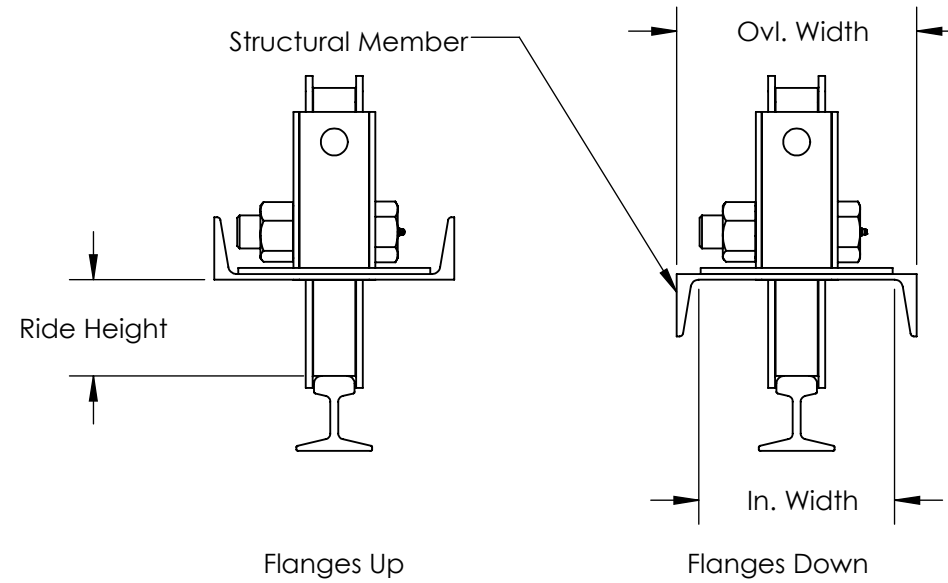
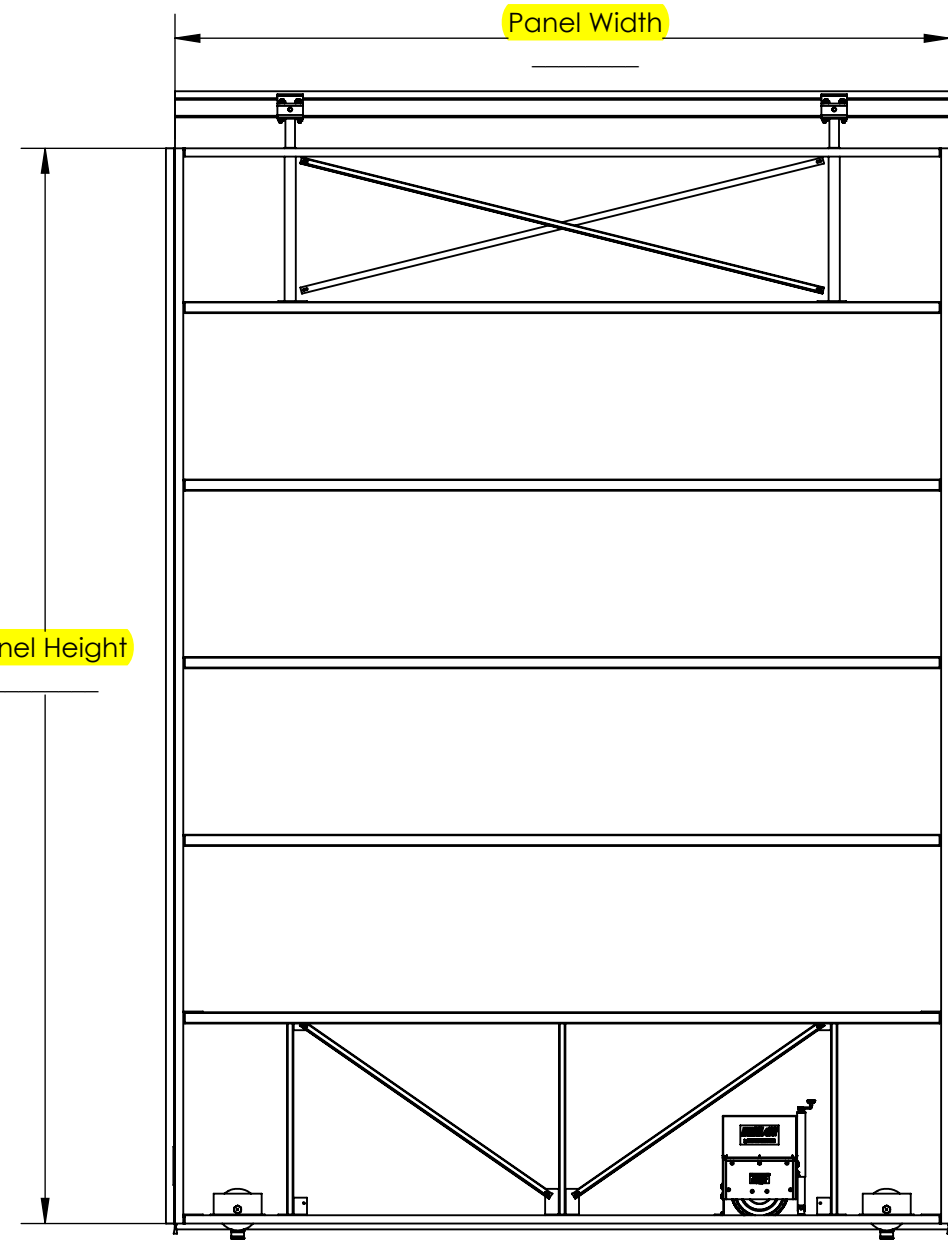

DETAILS:

Flange Style _____

Structural Member _____

Overall Width _____

Inside Width _____

Ride Height _____

PROPRIETARY AND CONFIDENTIAL
 THE INFORMATION CONTAINED IN THIS DRAWING IS THE SOLE PROPERTY OF WELL BILT INDUSTRIES. ANY REPRODUCTION IN PART OR AS A WHOLE WITHOUT THE WRITTEN PERMISSION OF WELL BILT INDUSTRIES IS PROHIBITED.

Approved:	Revised:	Customer:
Panel Weight:	Panel Qty:	Wind Load:
CUSTOMER: Company _____ Address _____ Contact Name _____ Phone Number _____		
PROJECT: Name _____ Address _____ Job Number _____		
TITLE:		Operator Purchase Form